

Separation Distances and Amenity SPD



1. Purpose of document

- 1.1 The purpose of this document is to improve the overall spacing standards for new residential developments to ensure that existing and future residents have a good level of amenity and privacy to enjoy the place where they live.
- 1.2 This document is intended to ensure developers provide sufficient amenity and privacy for existing and future residents across East Staffordshire.
- 1.3 The provision of adequate space between dwellings is an important element in achieving a high standard of design and layout and provides:
 - adequate daylight and sunlight to rooms and rear gardens;
 - reasonable privacy for dwellings within their proposed layout and to protect the privacy of existing dwellings;
 - a satisfactory level of outlook, within new development and in relation to existing development;
 - a reasonable area of private amenity space to allow such uses as drying washing, gardening and children's play, together with space for garden sheds, greenhouses and future adaptations to the dwelling;
- 1.4 This SPD is intended to ensure retention of amenity in all aspects of development, and ensure that by addressing one issue others are not compromised.
- ~~1.5~~ This SPD ~~has been in place since~~ **was first adopted in** 2019 however following a review it was considered that there are many circumstances where additional guidance is required to assess the impact of development on existing properties. As a result several changes ~~are~~ **were** proposed with regards to the use of the '45 degree' code and also the introduction of the '25 degree code' **and to correct other omissions**. ~~The changes are~~ **highlighted** throughout the document.
- 1.6 This revised SPD **was** is subject to a 6 week consultation from Friday 7th June **to** Friday 19th July. ~~All consultation responses will be considered and reported to Members. If accepted, This~~ the revised Separation Distance and Amenity SPD, ~~together with any proposed changes, will be~~ **was** adopted for use in determining planning applications on xx/xx/2024.

2. When is this SPD applicable

- 2.1 This document will be used to ensure adequate separation and amenity standards are provided with regard to all new dwellings and extensions, post adoption. The guide also applies where new dwellings or extensions are proposed adjacent or opposing existing older properties to ensure that existing resident's standards or separation and amenity are protected and retained.
- 2.2 The SPD does not apply to proposals which are permitted development, as such proposals are outside the control of the Local Planning Authority.
- 2.3 Guidance on what developments are considered permitted development ie do not require planning permission can be found on the Planning portal Website below,

https://www.planningportal.co.uk/info/200125/do_you_need_permission

3. Policy

- 3.1 This SPD supports the application of Local Plan Policy SP24 “High Quality Design” and Policy DP3 “Design of New Residential Development, Extensions and Curtilage Buildings” and this document builds on the above policies and seeks to provide greater clarity to developers and residents as to what standards are required to be met in terms of proposals for new housing and extensions.
- 3.2 You are advised to discuss your proposal with the Council at an early stage. Formal pre-application discussions can help avoid problems and delays once an application is submitted. Further information, including the Pre-application Advice service and charges for this, is available on the Council’s website.

4. Spacing standards

- 4.1 New housing developments should ensure a layout and design that provides high standards of privacy and outlook for both existing and proposed residents. Proposals should avoid the following in order to encourage high levels of amenity and privacy:
1. Siting new dwellings close to existing properties such that overlooking of existing windows and gardens occurs, significantly reducing existing levels of amenity.
 2. Significant overbearing impacts on existing properties and their private amenity space.
 3. The intensification of vehicular and pedestrian activity close to the boundary with existing residential properties or their gardens.
- 4.2 The external Spacing standards set out below will be expected and are intended to ensure that adequate separation distances, privacy and amenity are retained and provided as a result of new development.

External Separation Standards

- 4.3 The minimum back to back distance between habitable rooms should be 21 metres where dwellings are of the same number of storeys. **This standard will also apply in circumstances where there are windows on the side elevation in back to side scenarios.**

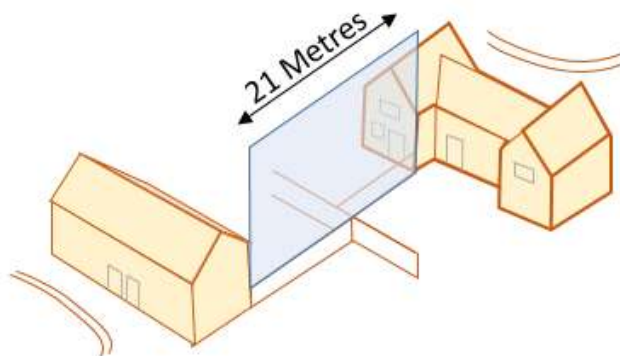

- 4.4 Where dwellings differ in scale or finished floor level by a metre or greater the back to back distance should be increased in separation by 2 metres for each additional 1 metre of elevation.

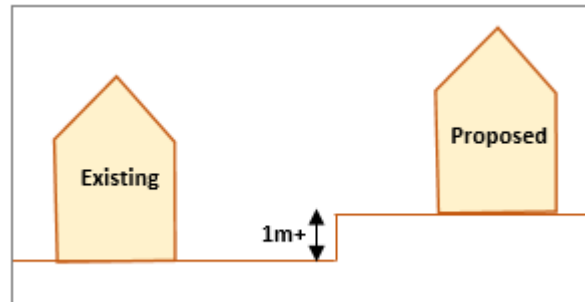

- 4.5 Separation to front elevations where level and or scale differences are apparent should also be increased however this would be on a 1 metre per 1 metre of elevation basis, as it is considered that frontages are of a less private nature than rear facades, however this will protect outlook and prevent any significant overbearing impact.
- 4.6 Cross sections are therefore required to be provided to demonstrate levels, separation and this relationship. This includes where residential development is proposed adjacent to existing residents and land levels differ.
- 4.7 Proposed walls without habitable windows such as blank gable side elevations opposing habitable principle elevations should be a minimum of 12 metres apart where dwellings are of the same number of storeys.

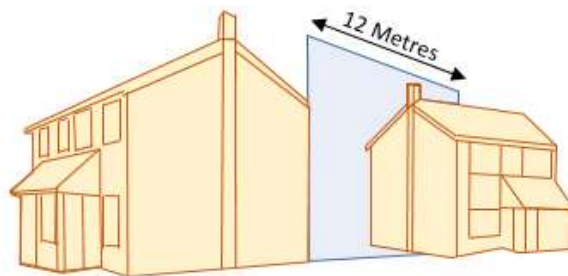

- 4.8 Where differing in scale the separation distance should be increased by 2 metres for each additional storey.

NOTE – Where developments offer only minimum separation the Local Planning Authority will remove permitted development rights for extensions and alterations to ensure they retain control over future extensions which would necessitate the requirement for planning approval, in order to ensure that adequate separation and privacy is retained and further guidance is available in this document.

NOTE – It should be noted that the separation distances between habitable windows also applies to apartment blocks and that where apartment blocks are proposed adjacent to residential dwellings.

Overlooking and Over-shadowing in new development

4.9 Loss of light, overlooking and overshadowing to neighbouring occupiers are important considerations in designing new development, especially in respect of extensions to existing buildings. In designing a new development or extension to a building or a dwelling house, care needs to be taken to safeguard the daylight to adjacent residential properties and protect them from overshadowing. The quality of daylight received by properties adjoining development sites can be severely restricted by buildings or extensions which are too close to the boundary or project too far into rear gardens.

4.10 Overshadowing is an issue created by the form and location of buildings. In most cases design details cannot alter the impact of the development on its neighbours. **This matter will be looked at alongside the 45 degree code set out below.** Overlooking is different in that design can help avoid potential problems such as the positioning of windows etc.

4.11 The East Staffordshire Local Plan contains policies which ensure that new development does not result in a material loss of light to principal windows of adjacent dwellings. In order to assess the impact of development on the existing light amenity enjoyed by neighbours, the Council will make use of the 45 Degree Check and the 25 Degree Check. The check aims to provide a reasonable balance between the wishes of those who would like to build and the light amenity enjoyed by the neighbouring occupiers. The Council will require the 45 Degree check to be shown on proposed plans as set out in local validation criteria.

When it is used

4.12 The 45 Degree Check will be taken from the nearest front or rear window ~~at ground floor level~~ which would be affected by the development. The window must be the main source of light to a 'habitable room'. Habitable rooms include Kitchens, living rooms, dining rooms and bedrooms. Non habitable rooms include bathrooms, halls and landings, utility rooms and garages.

How it is used

4.13 New development should not normally cross the line of a 45 degree angle drawn (in the horizontal plane) from the mid-point of the nearest ~~ground floor~~ habitable room window in the adjoining property to the new development. The mid-point of a window is usually measured both from a horizontal axis, taking the mid-point of the vertical axis as being 2m above ground floor level. For example, a window 3m wide would have its mid-point plotted at 2m on the vertical axis and 1.5m on the horizontal axis. **The diagrams below para 4.18 illustrate this however not all windows are included in the diagrams so if you need further advice please contact the planning department or use our Pre-app service.**

4.14 For large rooms, it may be considered that there is more than one principal window (e.g where a room extends from the back to the front of a house and there are windows on both the front and rear elevation). Appropriate allowances may be made if there is more than one source of light serving a neighbouring habitable room.

4.15 It will not normally be acceptable to design an extension with splayed corners, asymmetrical roof etc to avoid breaching the 45 Degree Line, as this **can result in discordant features which do not respect the design quality and results in leads to** poor design.

4.16 If neighbours submit joint planning applications for extensions which are of the same size and to be built at the same time, the extensions may be allowed, even if separately they would have breached the 45 Degree Code. In these cases, neighbours must confirm in writing that the extensions would be built at the same time. The 45 Degree Check would be applied in the normal way to any other neighbouring dwellings which may be affected.

4.17 Bay/ Bow Windows- If the neighbouring property has a bow or bay window, the measurement is taken from the mid point at the back of the window where it joins the main wall of the house or flat. However, if the bay has solid brick sides which extend the full height of the window opening, then the measurement is taken from the glazed part of the window itself as shown below.

4.18 If the neighbouring property has a conservatory, or an extension mainly made from glass, the 45 Degree line is taken from the original window opening in the wall of the house where the conservatory has been added.

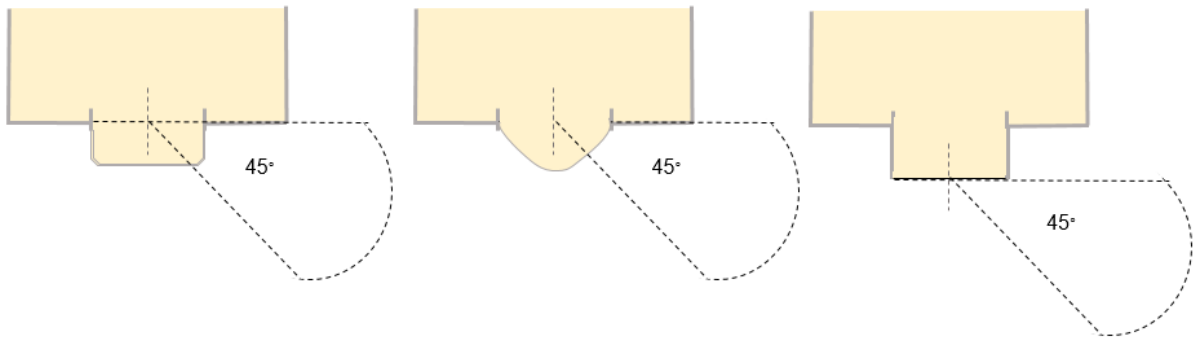

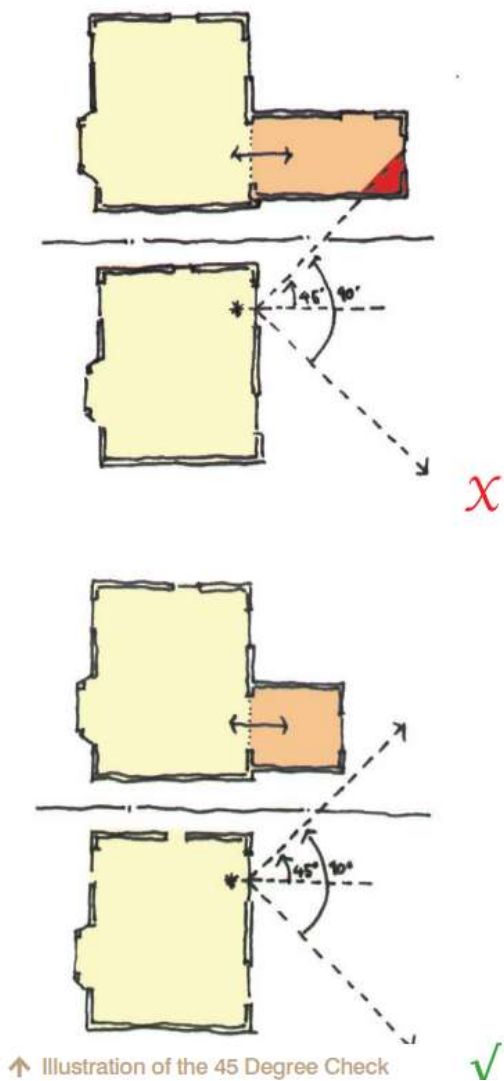

Site Considerations

4.19 The 45 Degree Check should be applied carefully, and is simple to apply in most cases. However, each application is assessed on its own merits and the following circumstances may be taken into consideration:

- If the ground levels are different between properties. This may either improve or worsen the effect of a new development and appropriate allowances must be made.
- The distance between the new development/ building and the neighbouring property should also be given consideration. The greater the distance the less the effect there may be on the neighbours light and outlook.
- If there is a solid intervening feature, such as a boundary wall, permanent outbuilding or some other kind of solid screen between the properties, this should be given consideration. If the new development/ building is not significantly larger than the wall then it may be acceptable.

- A daylight assessment using the 25 degree calculation which demonstrates that sufficient light will remain available to neighbouring occupiers may be given consideration in the determination of a planning application.

4.20 Innovative and careful design can help to overcome potential problems and the Council promotes a design led approach to this issue. The following techniques will help to avoid potential problems of overlooking

- Assess and record all existing windows and private amenity spaces associated with neighbouring buildings and properties and the implications of these for the new development.
- Ensure the form of the new building responds to the challenge of the site and the adjacent buildings to create appropriate separation between new and existing, considering the 45 degree check;
- Use directional windows where the orientation of windows is controlled within the wall of the building to avoid direct overlooking and sensitive interfaces. Directional windows can create architectural features both internally and externally;
- Use high and low windows within a room where 'strips' of glazing towards the top and bottom of the room space replace standard (mid) height windows on sensitive interfaces. The aim is to avoid windows at or close to 'eye level' either when standing or sitting within the space;
- Use roof windows to light a room from above and avoid the need for windows within walls. This is generally more suitable for smaller rooms in residential developments, such as bathrooms, but can work effectively alongside other high- level windows in larger nonresidential spaces, such as galleries, leisure, education and commercial developments; and
- Use **obscure opaque** glazing where necessary to limit views out of (and into) rooms. This approach should not be used for large and prominent windows, or as a cheaper alternative to architectural design solutions.

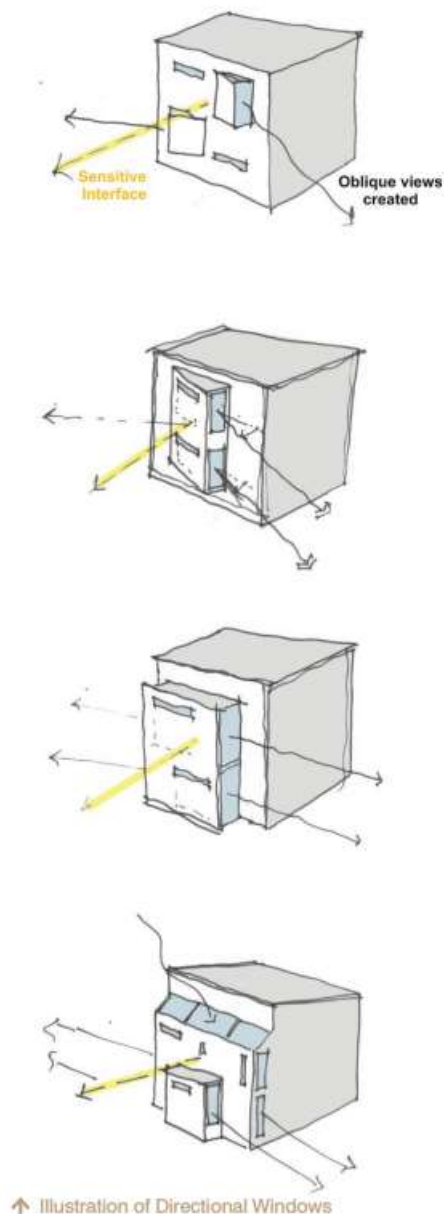

4.21 If the proposal does not allow for the 45 degree assessment to be made, or if after carrying out the 45 degree test, it is found that a development crosses the 45 degree line, it does not automatically mean that it is unacceptable. In these cases, a second test is to be used to check whether the development would be so close and high in relation to neighbours' windows that it would cause unacceptable loss of light.

4.22 This time the line from the mid-point of the habitable room window is drawn in the vertical plane. If the top of the new development would cross the line of a 25 degree angle above horizontal, the development will normally cause excessive loss of light and be unacceptable subject to other considerations as outlined below:

- The availability of alternative sources of natural light to the affected room(s). e.g are there other windows serving the room;
- The size and function of the room, e.g are they habitable rooms
- other buildings or features in the area which may, for example, already cause loss of light and overshadowing;
- the orientation of the building; and
- the design and character of the property and nearby properties.

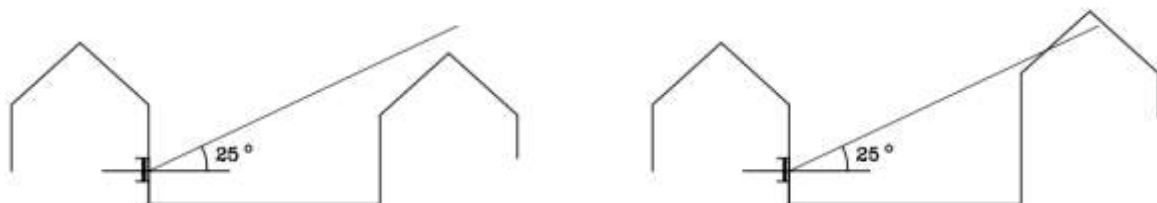
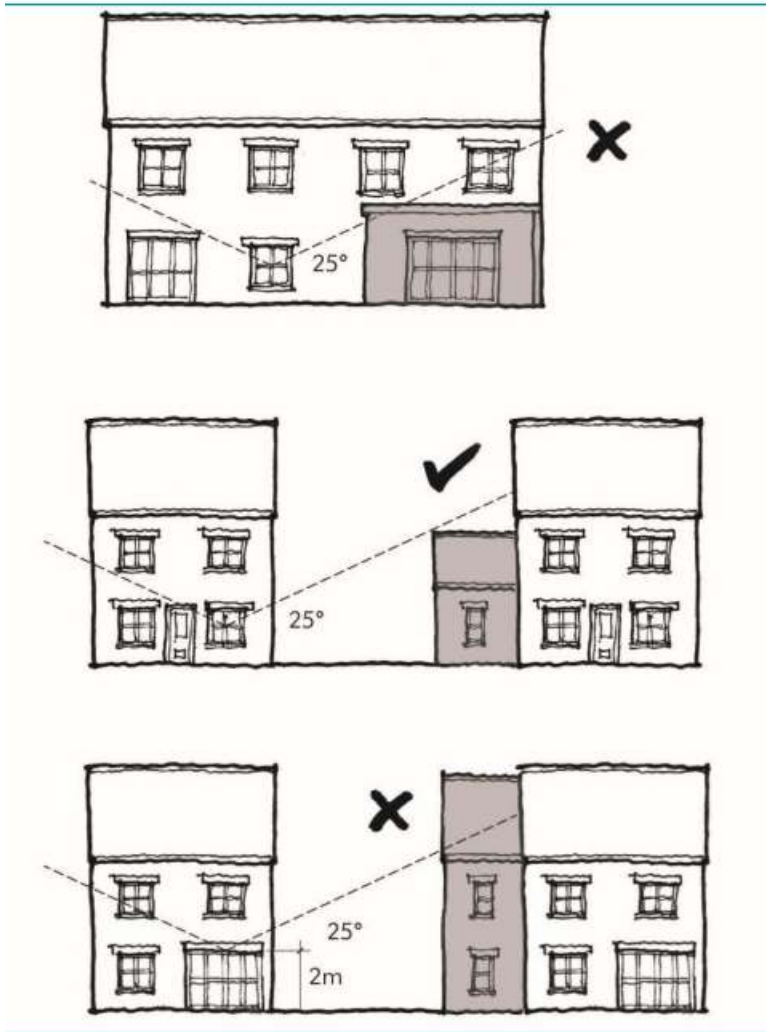

Illustrations of the 25 degree rule

4.23 To assist in some circumstances applicants may be required to provide a daylight assessment.

Amenity Standards

4.24 Private garden spaces are an essential component of high quality design, and a key to the creation of a sustainable residential environment, in terms of contributing to liveability, recreation and health, to urban greening, and the preservation or enhancement of local biodiversity. Garden spaces should be sufficient to accommodate most household activities and at the same time be adequate to offer visual delight, receive some sunshine, and encourage plant growth.

4.25 Private rear gardens of proposed dwellings should be a minimum of 50 sq. metres in area for two bedroom properties, with at least an additional 10 sq. metres for each additional bedroom.

Size of property	Minimum Garden Size (Sq. m)
1 or 2 bedroom house	50
3 bedroom house	60
4 bedroom	70
5 bedroom +	80
Apartments/flats	10 per unit

4.26 New apartments/ flats should achieve communal amenity areas with 10 square metres per unit, this excludes apartment developments resulting from conversions as generally they do not have sufficient space to facilitate this.

4.27 All shared amenity and play space must have an identified body to manage and maintain the space in accordance with an agreed management plan.

4.28 Where rear gardens have publicly accessible routes to side and/ or rear boundaries in the form of pedestrian routes, highways etc. the level of privacy afforded to the garden space is reduced due to activity in close proximity and potential overlooking. Developers should be mindful to design residential layouts with private amenity spaces which offer a high level of privacy for end users.

4.29 Rear gardens should be a minimum of 10 metres in length. A reduced distance maybe acceptable for layouts where dwellings are able to meet the garden size requirement with a reduced length and retain a strong level of privacy for instance where there is no opposing property or garden or where bungalows are proposed which are land hungry and dictate a wider plot or in rural areas where the character of surrounding properties provides a particular circumstance. It is for the applicant to justify the approach to the local planning authority.

4.30 A garden length of 10 metres with a dwelling width of 5 metres will meet the 50 sq. metre requirement.

4.31 Appropriate sized gardens are essential in offering appropriate living conditions, and also to factor in future adaptability of properties to suit the properties users. Gardens of inadequate size fail to facilitate the potential for introduction of outbuildings or allow the properties to be extended in line with permitted development rights.

4.32 It should be noted that developments which result in gardens built up to a higher level relative to other residents or their gardens will not be supported as this would result in an

unacceptable impact on amenity and privacy. Developers should ensure that layout and/ or engineering solutions are provided to negate significant level differences between gardens.

NOTE – private gardens are considered for the most part to be rear gardens. Areas rear of the front elevation will only be considered as private where a front garden is also proposed which sets the properties frontage back from the public highway and offers a greater degree of privacy to the side.

Frontage landscaping/gardens

- 4.33 Frontage landscaping provide a buffer to the front of the frontage of properties and breaks up the space from the highway and offers a more visually appealing and softer landscape. Front gardens offer some degree of landscaped boundary to the frontage is a welcome feature, and where this is undertaken to a high standard improves the overall layout of developments significantly. Developments incorporating frontage gardens or grassed areas will be viewed more positively.

Outlook and Amenity

- 4.34 Proposals that put forward unusual design solutions such as obscure glazing and high level windows to principle elevations or habitable windows to one elevation only with limited or no outlook are unlikely to be acceptable and highlight that a layout should be altered to offer a more comprehensive solution to the sites constraints. The aforementioned methods may only be incorporated to non-habitable or secondary windows.

Design of residential parking and garaging

- 4.35 Details of parking requirements are covered within the Parking SPD.
- 4.36 Driveways should be a minimum of 3.2 metres wide to allow doors to be opened and closed. Where developments incorporate a specific parking area bays should be a minimum of 2.4 metres wide, car doors can still be opened as cars do not fill the whole bay which allows additional space either side, which isn't the case for domestic driveways.
- 4.37 Developments should seek to avoid a proliferation of frontage parking, and should seek to avoid this by breaking up street frontages with drives to the sides and landscaped front gardens.
- 4.38 Garages should be a minimum of 6 metre by 3 metres internally to be considered as a single parking space.

5. Extensions and Future adaptations

- 5.1 Where a minimum separation distance exists the ability of future occupiers to adapt and extend properties will as a result be restricted as for instance a two storey extension would then break the above identified separation distance. However single storey extensions may well be feasible where adequate private garden space is retained.
- 5.2 These separation distances apply to adaptations of existing dwellings, where 2 storey extensions are proposed as per the below, first floor elevations will be expected to meet the 21 metre rule.



5.3 A separation distance of 21 metres will be expected at first floor level however where sufficient garden space remains a single storey extension of 3 metres to each opposing property is feasible which would retain 15 metres (indicated by the arrow) between ground floors as extended, i.e. 7.5 metres of garden length to the rear of each property.

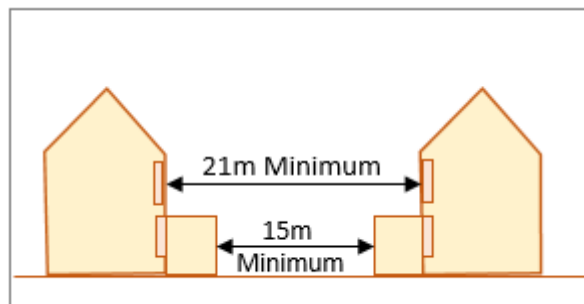

5.4 Principal habitable windows are defined as windows serving living rooms, play rooms, dining rooms, kitchens and bedrooms. A primary window is the main or only window to which light illuminates the identified room. Less weight is given to secondary windows due to the existence of the primary source of light. Landing windows are not considered to be principal windows.

6. Internal Spacing Standards

- 6.1 Internal spacing is also essential in ensuring that new dwellings provide room sizes which meet their function and are useable in a manner that is fit for their intended use.
- 6.2 The minimum standards for internal spaces set out in the table below have been derived from a comparative analysis of a range of sources including detailed research and minimum space standards adopted by a number of local authorities and Technical Housing Standards – nationally described space standard March 2015.¹
- 6.3 The aim of prescribing a minimum standard is to ensure adequate amenity for end users of the rooms. To further ensure this is achievable rooms should avoid unusual shapes to achieve a minimum area which would render them dysfunctional in layout, as such the below standards should also be met.

Technical requirements

- a) A dwelling with two or more bedrooms has at least one double or twin bedroom
- b) A single bedroom should be at least 2.2 metres wide.
- c) Double or twin bedrooms should be a minimum of 3 metres in length and 2.6 metres wide. With single bedrooms 2 metres in width as a minimum.
- d) Ceiling heights should be a minimum of 2.3 metres
- e) Living rooms should have a width or length of at least 3.2 metre

Table outlining internal spacing standards:-

Dwelling Size	Studio 1 person	1 bed 1 person	1 bed 2 person	2 bed 3 person	3 bed 4 person	4 bed 5 person or more
Double bedroom		12	12	12	12	12
Single Bedroom			7.5	7.5	7.5	7.5
Living Room		13	13	13	15	15

¹ The NDSS has been updated and if this standard is preferred by the applicant then this should be outlined in the accompanying planning statement.

Living/ Dining		16	16	17	18	19
Kitchen		13	9	11	13	13
Open Plan combined Kitchen/ Dining/ Living		24	24	27	30	33
Bathroom/ Wc combined	3.5	3.5	3.5	3.5	3.5	3.5
Storage	1.5	2.5	3.5	3.75	4.5	5.5
Overall Floor Area	33 sq m	46 sq m	47 sq m	62 sq m	77 sq m	93 sq m

Other Considerations: Right to Light Legislation

- 6.4 The right to light is a legal right which one property may acquire over the land of another. If a structure is erected which reduces the light to an unobstructed property to below sufficient levels, this right is infringed. A right to light can come into existence if it has been enjoyed uninterrupted for 20 years or more, granted by deed, or registered under the Rights of Light Act 1959.
- 6.5 Planning permission does not override a legal right to light. There also may be instances where development built under permitted development rights compromises light levels to an existing window.
- 6.6 In both instances, where a right to light is claimed, this is a matter of property law, rather than planning law. It will therefore be for the parties affected to seek a legal remedy separate from the planning application process. The Council will have no role or interest in any private dispute arising and it will be for the owner or occupier affected to seek a legal remedy. Impact on right to light will not therefore justify a reason to refuse planning permission